

Studio Collection

A select range of appliances

 **Hotpoint**





OUR IDEAS. YOUR HOME.



Sophisticated technology.
Intelligent features. Stylish
design. All this and more
in our Studio Collection.

Our ideas. Your home.

Inspired by you, we've developed an exclusive collection of appliances utilising the best technology to provide intelligent features all wrapped up in a stunning design. Intelligent Cooking programmes and self-cleaning Pyrolytic options on our ovens, Double Face Elliptical burners on our gas hobs, SuperSilent hoods and dishwashers, Eco Cycles on our integrated laundry products all complete this sophisticated range. There's even perfect storage for your wine with the integrated 24 bottle wine cellar.

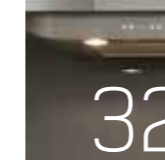
Our Collection	Cooking	Dishwashing	Laundry	Refrigeration	Specifications
 4	 8	 26	 28	 30	 32



Experience Range

Hotpoint's fingerprint resistant Experience Steel range is as beautiful as it is sophisticated. We've combined stylish looks with powerful performance. Blended the latest technology with bold innovative design. Then applied this to every detail across the full range of appliances.



NewStyle Range

A focus on smooth curves and meticulous detailing. This new cooking range aesthetic will complement any kitchen style with its sense of strength and exceptional finish.

Available across ovens and hobs with a matching hood, NewStyle will make a real design statement in your home.



Ovens

Openspace
Experience & NewStyle
Single
Built-In Double
Built-Under Double

The oven is at the heart of your kitchen so it needs to look outstanding and perform well too. Hotpoint's Studio Collection features a selection of single and double ovens featuring the very latest in technology, all set-off with our stylish Experience and NewStyle designs.

OPENSOURCE

Openspace is Hotpoint's revolutionary new oven that gives 20% more space than a standard single oven within the same dimension, providing 70 litres of cooking capacity. But the brilliance doesn't end there. Convert this extra large space into a double oven by simply inserting the insulating divider to create two separate cooking zones; both with independent time and temperature controls.

OPENSOURCE

Single/Double
Ovens



OS897DPIX

13 Cooking Programmes:

Small Space: Fast Cooking, Grill

Main Space: Circulaire Fan

Double Space: Main and Small Space features combined.

Extra Large Space

4 Intelligent Programmes:

Roast, Bread, Cake, Pizza

6 Standard Programmes:

Multi-Cooking, Fan Grilling, Grill, Low Temperatures 40°C, 65°C & 90°C

Insulating Divider

2 Halogen Lights

Fast Clean Pyrolytic Cycle

Total Electronic Control

Two Individually Controlled Electronic Programmable Timers with Time and Temperature Control

Triple Glazed Door



Fast Clean Electric Multifunction Single/Double Oven

Finish: Stainless Steel - Fingerprint Resistant

PENSPACE

Please see pages 22-41 in the main Built-In brochure for the full range of Hotpoint ovens.



Just add the divider and you have a double oven.



OS897DCIX

13 Cooking Programmes:

Small Space: Fast Cooking, Grill

Main Space: Circulaire Fan

Double Space: Main and Small Space features combined

Extra Large Space

4 Intelligent Programmes:

Roast, Bread, Cake, Pizza

6 Standard Programmes:

Multi-Cooking, Fan Grilling, Grill, Low Temperatures 40°C, 65°C & 90°C

Insulating Divider

Two Individually Controlled Electronic Programmable Timers with Time and Temperature Control

2 Halogen Lights

Easy Clean Oven Finish (Catalytic Liners)

Easy Clean Inner Door Glass

Triple Glazed Door



Electric Multifunction Single/Double Oven

Finish: Stainless Steel - Fingerprint Resistant

EXPERIENCE

Single Ovens



Fast Clean Pyrolytic Cycle cleans the oven by itself.



AHP69PG

8 Cooking Programmes:

Conventional, Multi-Cooking, Grill, Pizza, Fan Grilling, Circulaire Fan, Rotisserie, Low Temperature 65°C

Fast Clean Pyrolytic Cycle

24 Hour Electronic Programmable Timer with Time and Temperature Control

Variable Grill

Air Flow Cooling Fan and Internal Chimney Venting

Quadruple Glazed Door

A Energy Rating

Retractable Controls



Fast Clean Electric Multifunction Single Oven

Finish: Stainless Steel (X) - Fingerprint Resistant

EXPERIENCE Single Ovens



AHP662

6 Cooking Programmes:

- Conventional, Multi-Cooking, Pizza, Grill, Fan Grilling, Circulaire Fan
- 2 Telescopic Shelves
- Easy Clean Oven Finish (Catalytic Liners)
- 24 Hour Electronic Programmable Timer with Time Control
- Variable Grill
- Air Flow Cooling Fan and Internal Chimney Venting
- Double Glazed Door
- Easy Clean Inner Door Glass
- A Energy Rating



Electric Multifunction Single Oven

Finish: Stainless Steel (X) - Fingerprint Resistant



AHP66

6 Cooking Programmes:

- Conventional, Multi-Cooking, Pizza, Grill, Fan Grilling, Circulaire Fan
- Easy Clean Oven Finish (Catalytic Liners)
- 24 Hour Electronic Programmable Timer with Time Control
- Full or Half Grill Option
- Air Flow Cooling Fan and Internal Chimney Venting
- Double Glazed Door
- Easy Clean Inner Door Glass
- A Energy Rating



Electric Multifunction Single Oven

Finish: Stainless Steel (X) - Fingerprint Resistant



AHP67

10 Cooking Programmes:

- Main Oven:**
- 5 Intelligent Programmes:** Roast Meat, Roast Chicken, Fish, Cakes, Bread
- 3 Standard Programmes:** Circulaire Fan, Conventional, Proving
- Top Oven:** Conventional, Solarplus Twin Variable Grill
- 24 Hour Electronic Programmable Timer with Time and Temperature Control
- Easy Clean Oven Finish (Catalytic Liners)
- Triple Glazed Door
- AA Energy Rating
- Retractable Controls



Electric Multifunction Built-In Oven

Finish: Stainless Steel (X) - Fingerprint Resistant



AHP37

4 Cooking Programmes:

- Main Oven:** Circulaire Fan, Defrost Setting
- Top Oven:** Conventional, Solarplus Twin Variable Grill
- 24 Hour Electronic Programmable Timer with Time Control
- Easy Clean Oven Finish (Catalytic Liners)
- Triple Glazed Door
- Retractable Controls



Electric Multifunction Built-Under Oven

Finish: Stainless Steel (X) - Fingerprint Resistant

EXPERIENCE

Double Ovens

Please see pages 28-29 and 38-41 in the main Built-In brochure for the full range of Double Ovens.



Solarplus Twin Grill heats up in 15 seconds.

NEWSTYLE

Single Ovens

Please see pages 22-27 and 34-37 in the main Built-In brochure for the full range of Single Ovens.



SH103P

10 Cooking Programmes:

4 Intelligent Programmes:

Roast, Bread, Cake, Pizza

6 Standard Programmes:

Circulaire Fan, Fan Grilling, Variable Grill, Low Temperatures 40°C, 65°C & 90°C

1 Standard Light

Fast Clean Pyrolytic Cycle

Total Electronic Control

24 Hour Electronic Programmable Timer with Time and Temperature Control

Triple Glazed Door



Fast Clean Touch Control Electric Multifunction Oven

Finish: Stainless Steel (X)

NEWSTYLE Single Ovens



SH89C

8 Cooking Programmes:

Fast Cooking, Fan Grilling, Variable Grill,

Circulaire Fan, Proving, Pastries,

Pizzas, Conventional

Easy Clean Oven Finish (Catalytic Liners)

24 Hour Electronic Programmable Timer with

Time and Temperature Control

Variable Grill

Air Flow Cooling Fan and Internal

Chimney Venting

Triple Glazed Door

Easy Clean Inner Door Glass



Electric Multifunction Single Oven

Finish: Stainless Steel (X)



SH83C

8 Cooking Programmes:

Fast Cooking, Fan Grilling, Variable Grill,

Circulaire Fan, Proving, Pastries,

Pizzas, Conventional

Easy Clean Oven Finish (Catalytic Liners)

24 Hour Electronic Programmable Timer

with Time Control

Variable Grill

Air Flow Cooling Fan and Internal

Chimney Venting

Triple Glazed Door

Easy Clean Inner Door Glass



Electric Multifunction Single Oven

Finish: Black (K)

Please see pages 28-29 and 38-41 in the main Built-In brochure for the full range of Double Ovens.



SH53C

5 Cooking Programmes:

- Conventional, Variable Grill, Circulaire Fan
- Fan Grilling, Top Heat
- Easy Clean Oven Finish (Catalytic Liners)
- 24 Hour Electronic Programmable Timer with Time Control
- Air Flow Cooling Fan and Internal Chimney Venting
- Double Glazed Door
- Easy Clean Inner Door Glass



Electric Multifunction Single Oven

Finish: Stainless Steel (X)



SHS33C

3 Cooking Programmes:

- Circulaire Fan, Fan Grilling, Variable Grill
- Easy Clean Oven Finish (Catalytic Liners)
- 24 Hour Electronic Programmable Timer with Time Control
- Air Flow Cooling Fan and Internal Chimney Venting
- Double Glazed Door
- Easy Clean Inner Door Glass



Electric Multifunction Single Oven

Finish: Stainless Steel (X)



DH99C

10 Cooking Programmes:

Main Oven:

5 Intelligent Programmes:

- Roast Meat, Roast Chicken, Fish, Cakes, Bread

3 Standard Programmes:

- Circulaire Fan, Conventional, Proving

Top Oven:

- Conventional, Solarplus Twin Variable Grill

- Electronic Timer with Time and Temperature Control
- Easy Clean Oven Finish (Catalytic Liners)
- Lights in Both Ovens
- Air Flow Cooling Fan and Internal Chimney Venting
- Triple Glazed Door
- Easy Clean Inner Door Glass



Electric Multifunction Built-In Oven

Finish: Stainless Steel (X)



Hobs

Gas Hobs

Electric Hobs

Built-in hobs not only provide a multitude of cooking options, from stir-frying to poaching, their ultra-modern styling adds a sophisticated finishing touch to your kitchen.

Induction Hobs

Energy efficient, clean, safe and controllable. Induction cooking uses a magnetic field to generate heat instantly, which is only activated by the presence of a pan. Only the cooking zone becomes warm, leaving the rest of the hob much cooler than on an ordinary ceramic hob.

EXPERIENCE

Gas Hobs

Please see pages 56-65 in the main Built-In brochure for the full range of Hobs.

4 burner sizes for cooking flexibility.



GQ751TS

- 5 Gas Burners:
 - 1 Mini Wok, 1 Rapid
 - 2 Semi Rapid, 1 Standard
- Cast Iron Pan Supports



75cm Gas on Glass Hob

Finish: Ice (I)

NEWSTYLE

Gas Hob

Please see pages 56-65 in the main Built-In brochure for the full range of Gas Hobs.



Double face burners, use together for fish kettles or big pans.



GF761RF

5 Gas Burners:
1 Double Ring, 1 Rapid, 1 Standard, 2 Double Face
Cast Iron Pan Supports



75cm Gas Hob

Finish: Stainless Steel (X)

EXPERIENCE

Electric Hobs

Please see pages 58-60 in the main Built-In brochure for the full range of Experience Electric Hobs.



Touch control hobs for great functionality and precise temperature control.



CIO744DO

4 Cooking Zones:
2 x 1.4kW (with Booster up to 2kW)
1 x 2.2kW (Double Ring with Booster up to 3kW)
1 x 2.2kW (Oval with Booster up to 3kW)
Child Lock
4 Individual Timers - 1 for each Cooking Zone



70cm Touch Control Induction Hob

Finish: Bevelled (B)



CIO644DD

4 Cooking Zones:
2 x 1.4kW Zones (with Booster up to 2kW)
2 x 2.2kW Zones (with Booster up to 3kW)
Child Lock
4 Individual Timers - 1 for each Cooking Zone



60cm Touch Control Induction Hob

Finish: Experience Profile (Z)

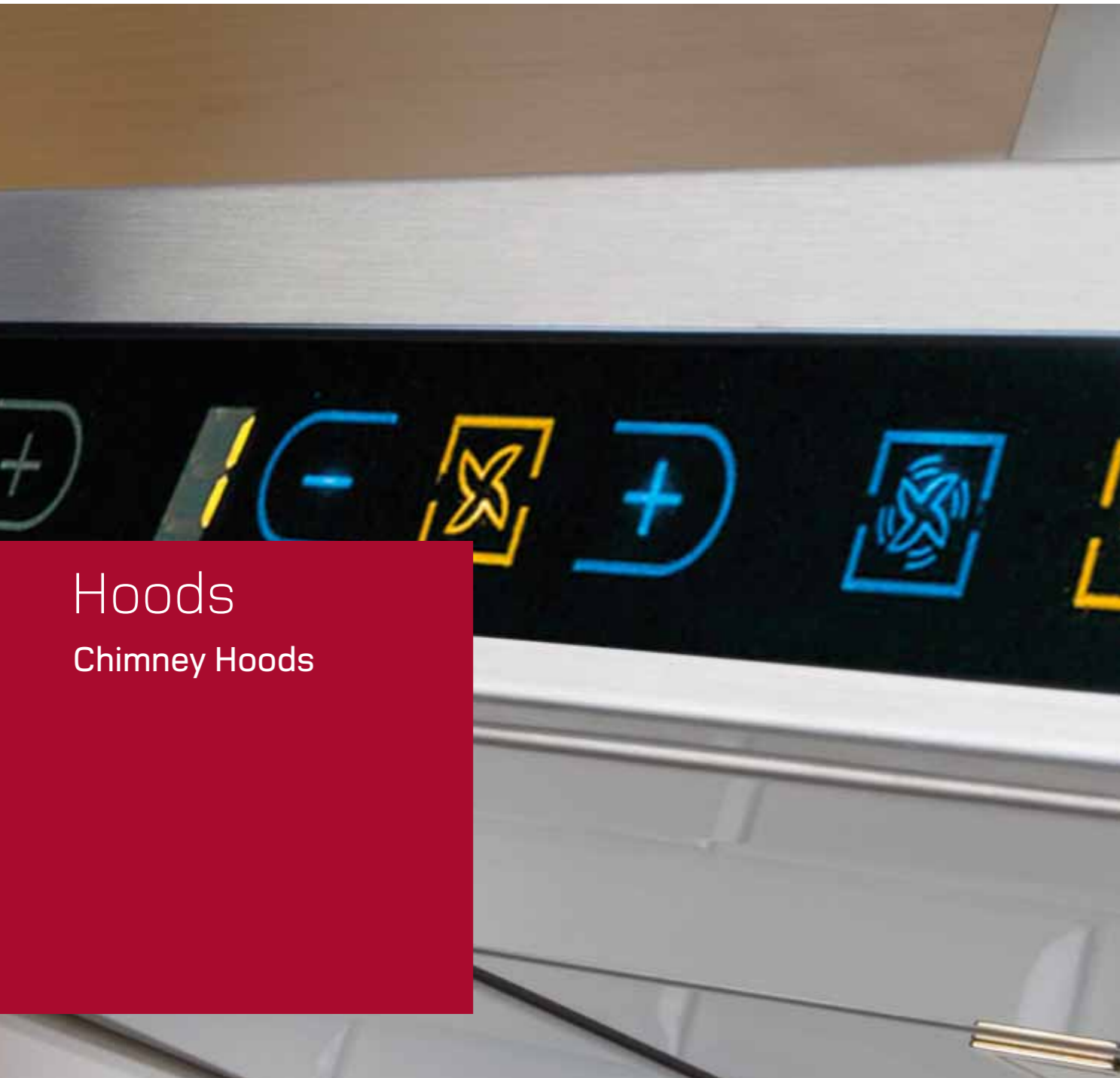

Hoods
Chimney Hoods

A cooker hood is a main feature of your kitchen as well as being functional. Our Studio Collection demonstrates 3 of the very best designs, to dramatically set off your chosen kitchen style.

Quietest Cooker Hood

The HTS93GX has an impressive maximum extraction rate of 900m³ but with a minimum noise level of only 35dB(A). Fitted with a specially designed and patented deflector which improves the air circulation, the perceived noise is brought down to nearly inaudible levels. To put another way, a normal conversation is around 60dB(A), and a quiet whisper from 3 feet away is around 30dB(A).

Hoods

Please see pages 74-81 in the main Built-In brochure for the full range of 90cm, 70cm and 60cm hoods..

 Touch Control hoods for added sophistication.



HTS93G

- Super Silent – 35dB(A)
- Touch Control
- Booster
- 2 x 20 Watt Halogen Lights
- Self Supporting Dishwasher Safe Filters
- Carbon Filters Included

-  Touch control
-  Choice of width
90cm
-  Extraction
900 m³/hr
-  dB(A)
35
-  Charcoal filter

90cm Chimney Hood

Finish: Stainless Steel (X)

Hoods

Please see pages 74-81 in the main Built-In brochure for the full range of 90cm, 70cm and 60cm hoods.

Delay Timer turns the hood off automatically after 5 minutes – leaving your kitchen fresh for when you return.



HDF92

- 90cm Chimney Hood with Angled Glass
- Electronic Controls
- Booster
- Illumination - 2 x 20 Watt Halogen Lights
- 1 Auto Supporting Metal Filter

Choice of width
90cm

Extraction
620 m³/hr

dB(A)
65

90cm Chimney Hood with Angled Glass

Finish: Stainless Steel (X)



HSD9EIX

- Electronic Controls
- Booster
- Delay Timer
- Filter Alert
- 2 x 20 Watt Halogen Lights
- 1 Self Supporting Metal Filter
- Carbon Filters included

Choice of width
90cm

Extraction
780 m³/hr

dB(A)
66

Charcoal filter

90cm Chimney Hood with Flat Glass

Finish: Stainless Steel (X)
Also available in: 60cm - HSD6EIX, 70cm - HSD7EIX



Dishwashing

Perfect for those who need a dishwasher but don't want to spoil the seamless lines of the kitchen. Our fully integrated dishwasher offers all the innovative features you need but you get to choose a door panel to fit with your new kitchen design.

Flexipower

Our Flexipower motor drives our Intelligent Sensor System which assesses and modifies the temperature, duration, water pressure and number of rinses to ensure perfect cleaning results.

Goodnight

This option quietens everything down even further – perfect for running in the evening or overnight.

Dual Space Upper Baskets

Adjust the height of the top basket in one quick movement, even when it is fully loaded, to give even more space in the lower basket.

Dishwashing

Please see pages 88-90 in the main Built-In brochure for the full range of Dishwashers.



Baby Cycle – An intensive wash cycle designed to cleanse and remove harmful bacteria.



LFT321HX

12 Place Settings
11 Programmes
6 Temperatures
Electronic Water Softener Control
Natural Drying
Wash Programmes include:
Eco, Rapid 25, Goodnight, Shorttime, Half Load
Dual Space Upper Baskets
Fully Collapsible Lower Baskets
Digital Display
3, 6, 9hr Delay Timer
Waterstop Protection
Overflow Protection
Self Balancing Door
Extra-Silent - just 43dB(A)



Fully Integrated Flexipower Dishwasher

Finish: Cabinetry Door Required
Experience Fingerprint Resistant Stainless Steel Panel available **XDZH** with matching Experience handle.





Laundry
Washing Machine
Washer Dryer

The Hotpoint Studio Collection washing machines are designed to fit behind a cabinet door to create a seamless look in your kitchen whilst still offering best in class performance and state of the art features such as our Ready to Wear Cycle which will wash and dry a small load in just 60 minutes.

Eco

Hotpoint and Ariel have worked in partnership to develop a selection of energy saving Eco Cycles. Our 3 unique Eco Cycles include: Cottons, Synthetics and a Fast Wash. Choosing the Eco Cycles will help you to save around 50% to 70%* of the energy used.

*Energy savings are up to 50% for the Eco Cotton cycle, up to 68% for Eco Synthetic cycle and up to 70% for Eco Fast Wash cycle (all compared to an equivalent 30°C cycle).

Laundry

Please see pages 96-97 in the main Built-In brochure for the full range of Laundry.



Woolmark* Platinum Care – for the perfect Wool wash cycle.



BHWM149

Spin Speed: 1400rpm
Number of Wash Programmes: 16
Wash Programmes include:
Shirts, Lingerie, Baby Cycle, Delicates
3 Eco Cycles:
Cottons, Synthetics & Fast Wash
Variable Spin & Temperature
Unbalanced Load Detection System
Coin Trap Accessible from Front
LED Programme Progress Indicators



Built-In Washing Machine



BHWD149/1

Spin Speed: 1400rpm
Number of Wash Programmes: 16
Number of Dry Programmes: 3
Wash Programmes include:
Shirts, Ready to Wear,
Baby Cycle, Delicates
3 Eco Cycles:
Cottons, Synthetics & Fast Wash
Drying Programmes:
Cottons, Synthetics & Wool
3 Level Set and Forget Sensor Drying
Variable Spin & Temperature
Unbalanced Load Detection System
LED Programme Progress Indicators



Built-In Washer Dryer

Available Summer 2010

*In the UK and Eire the Woolmark is a Certification Trade Mark.

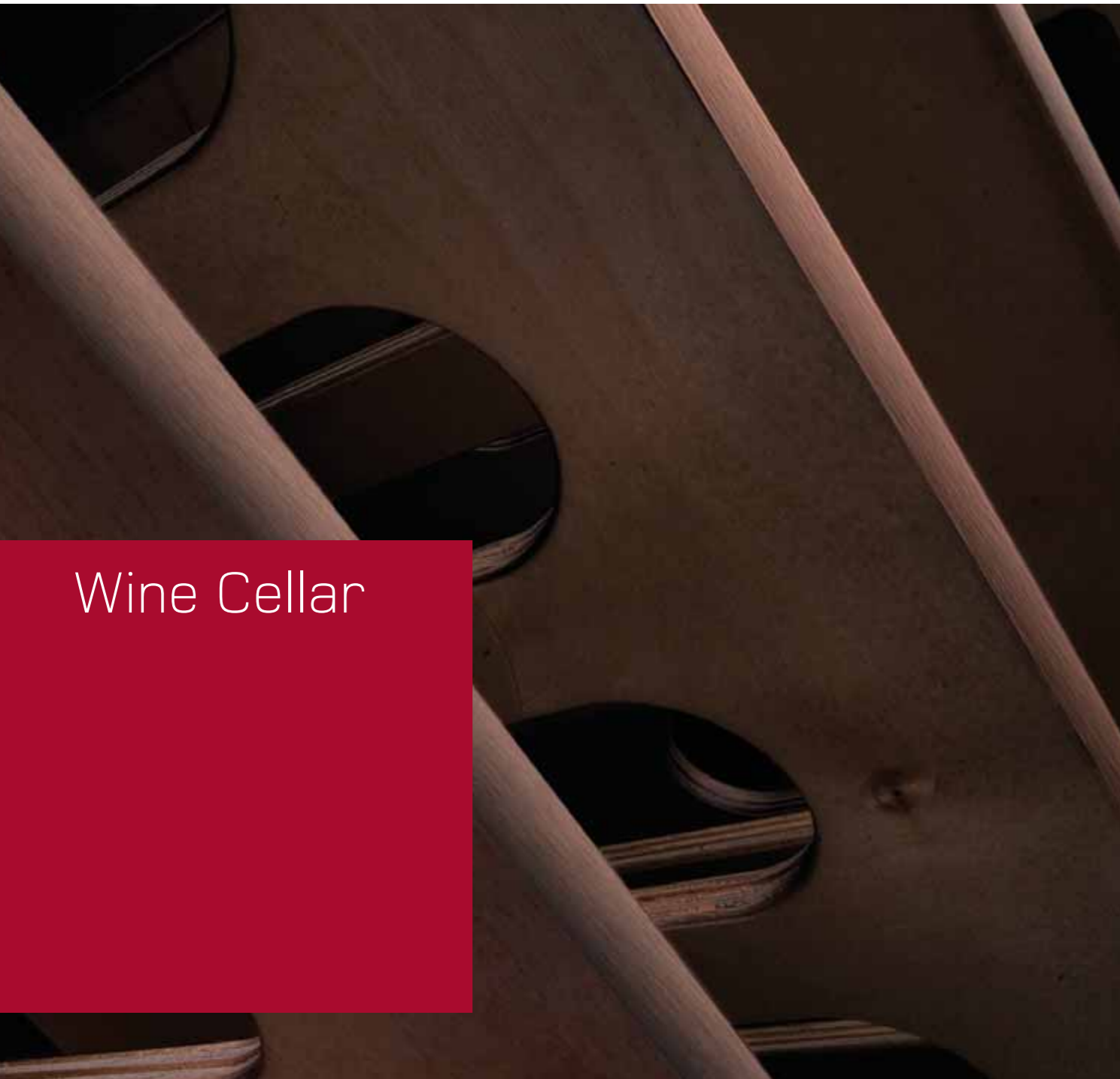

Wine Cellar

For true wine lovers, the Hotpoint Wine Cellar is the perfect solution for good wine storage. Temperature is the greatest concern when storing wine and the Hotpoint Wine Cellar ensures perfect storage and serving conditions every time.

Ideal Temperatures

A lot of the enjoyment of wine comes from the aroma, and you only get the right aroma if the wine is served at the correct drinking temperature. With the adjustable thermostat in the wine cellar you can make sure the wine is at the ideal temperature for serving, so for most white wines it will be around 7°C, for light-bodied reds and dessert wines it will be around 10°C and for more robust red wines it will be around 15-17°C.

Wine Cellar

Please see pages 104-117 in the main Built-In brochure for the full range of Refrigeration.

Built-In or Built-Under – install your wine cellar to suit your kitchen design.

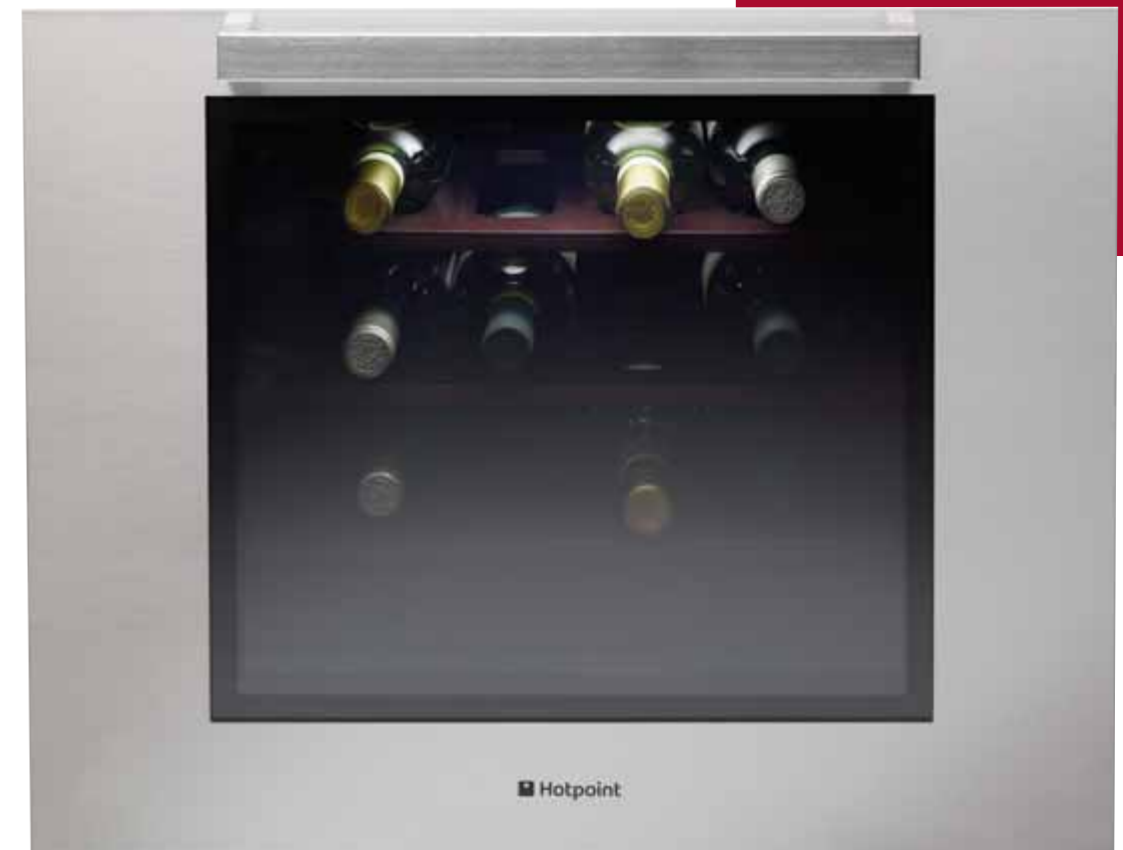

WE24

- Stores up to 24 Bottles
- Electronic Thermostat
- Temperature Regulation from +4°C to +20°C
- Internal Temperature and Working Indicator Display
- Internal Fan to Maintain Constant Air Temperature
- Anti-Condensation System
- Can be Built-In or Built-Under
- Tinted Glass and Black Interior to Reduce Light Transmission/Reflection Preserving the Wine for Longer

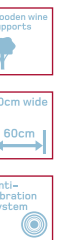

Wine Cellar

Finish: Stainless Steel (X) - Fingerprint Resistant

Specifications

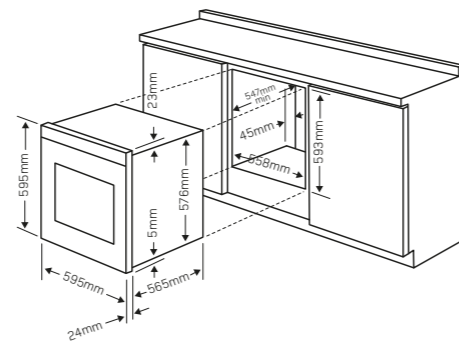

OS897DPIX, OS897DCIX & OS89CIX

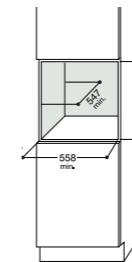
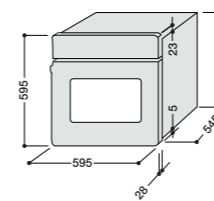

AHP69PG, AHP662, AHP66, SH103P, SH89P, SH89C, SH83C, SH53C, SHS33C

Single/Double Ovens

Model Number	OS897DPIX	OS897DCIX	OS89CIX
Finish			
Fingerprint Resistant Stainless Steel	•	•	•
Oven Type			
Electric	•	•	•
Cooking Functions	13	13	10
Roast	•	•	•
Cakes	•	•	•
Bread	•	•	•
Pizza	•	•	•
Multi-Cooking	•	•	•
Grill	•	•	•
Fan Grilling	•	•	•
Circulaire Fan	•	•	•
Fast Cooking	•	•	•
Low Temperature 90°C	•	•	•
Low Temperature 65°C	•	•	•
Low Temperature 40°C	•	•	•
Features			
Oven Divider	•	•	•
Control Type	Proud	Proud	Proud
24 hr Electronic Timer with Time/Temp Control	•	•	•
Oven Door Lock	•	•	•
Electronic Thermostat Control	•	•	•
Variable Grill	•	•	•
Halogen Oven Light	Side x 2	Side x 2	•
Standard Oven Light	•	•	Rear
Glazing Level	Triple	Triple	Triple
Air Flow Cooling Fan & Internal Venting	•	•	•
Cleaning			
Fast Clean/Pyrolytic with Grey Interior	•	•	•
Catalytic Liners	•	•	•
Easy Clean Full Inner Glass Door	•	•	•
Equipment			
Standard Tray	1	1	1
Grill Grid	3	3	3
Deep Tray	1	1	•
Power			
Total Power (W)	3600	2800	2800
Supply/Voltage (V/Hz)	230/50	230/50	230/50
Energy			
Energy Efficiency Class	A	A	A
Total Capacity (Litres)	70	70	70

Single Ovens

Model Number	AHP69PG	AHP662	AHP66	SH103P	SH89C	SH83C	SH53C	SHS33C
Finish								
X = Stainless Steel K = Black	X	X	X	X	X	K	X	X
Fingerprint Resistant	•	•	•	•	•	•	•	•
Oven Type								
Electric	•	•	•	•	•	•	•	•
Cooking Functions	8	6	6	10	8	8	5	3
Roast	•	•	•	•	•	•	•	•
Bread	•	•	•	•	•	•	•	•
Cake	•	•	•	•	•	•	•	•
Pizza	•	•	•	•	•	•	•	•
Multi-Cooking	•	•	•	•	•	•	•	•
Grill	•	•	•	•	•	•	•	•
Fan Grilling	•	•	•	•	•	•	•	•
Conventional	•	•	•	•	•	•	•	•
Circulaire Fan	•	•	•	•	•	•	•	•
Fast Cooking	•	•	•	•	•	•	•	•
Proving	•	•	•	•	•	•	•	•
Low Temp 40°C	•	•	•	•	•	•	•	•
Low Temp 65°C	•	•	•	•	•	•	•	•
Low Temp 90°C	•	•	•	•	•	•	•	•
Rotisserie	•	•	•	•	•	•	•	•
Pastries	•	•	•	•	•	•	•	•
Top Heat	•	•	•	•	•	•	•	•
Features								
Control Type	Retractable	Proud	Proud	Touch	Proud	Proud	Proud	Proud
24 hr Electronic Timer with Time/Temp Control	•	•	•	•	•	•	•	•
24 hr Electronic Timer with Time Control	•	•	•	•	•	•	•	•
Child Lock	•	•	•	•	•	•	•	•
Variable Oven Thermostat	•	•	•	•	•	•	•	•
Electronic Thermostat Control	•	•	•	•	•	•	•	•
Variable Grill	•	•	•	•	•	•	•	•
Oven Light	•	•	•	•	•	•	•	•
Glazing Level	Quad	Double	Double	Triple	Triple	Triple	Double	Double
Air Flow Cooling Fan & Internal Venting	•	•	•	•	•	•	•	•
Thermostat Light	•	•	•	•	•	•	•	•
Cleaning								
Fast Clean/Pyrolytic	•	•	•	•	•	•	•	•
Catalytic Liners	•	•	•	•	•	•	•	•
Easy Clean Full Inner Glass Door	•	•	•	•	•	•	•	•
Equipment								
Telescopic Shelves	•	2	•	•	•	•	•	•
Standard Shelves	2	•	2	3	3	3	3	3
Grill Tray	1	1	1	1	1	1	1	1
Deep Tray	1	1	1	•	•	•	•	•
Power								
Total Power (W)	2800	2800	2800	2800	2800	2800	2400	2400
Supply/Voltage (V/Hz)	230/50	230/50	230/50	230/50	230/50	230/50	230/50	230/50
Energy								
Energy Efficiency Class	A	A	A	A	A	A	A	A
Total Capacity (Litres)	56	58	58	56	58	58	58	58

Intelligent Solutions

Eco Tech

To keep up with our fast-changing world, Hotpoint aim to develop advanced technological solutions every year. These not only comply with strict environmental legislation but also make our products even more eco-friendly.



Hotpoint have developed an Eco Tech icon which we only award to our appliances that deliver the very best energy rating or have specific Eco features that will help save energy at home, such as:

- Eco Cycles on our washing machines
- Flexipower intelligent sensor system on our dishwashers giving optimum performance and low energy usage
- Openspace ovens, that heat up a huge 70 litre capacity using the same energy as a standard 56 litre oven

For additional Eco Tech models please refer to our main built-in brochure where you will find Energy Saving Trust recommended refrigeration appliances too.





Coffee Machine

Bring café culture to your home with the Hotpoint Coffee Maker which dispenses the perfect cappuccino, latte or espresso at the touch of a button.



Steam Oven

The fast, healthy and convenient way of cooking that seals valuable vitamins and minerals into your food.



Fridge Drawers

Hotpoint's award winning fridge drawers are styled to match latest kitchen designs with wide deep drawers and give easier access to contents.



Microwaves

Combination microwaves provide all the features of a standard oven - grill and fan cooking - but take a fraction of the time.

Experience More

The Studio Collection is just a taste of the extensive built-in appliance range that Hotpoint offer. Please ask your local kitchen studio for a copy of the Hotpoint Built-In Appliance Collection brochure for further details. To whet your appetite here are some of our other built-in appliances that will add true style to your chosen kitchen.

www.hotpoint.co.uk
www.hotpoint.ie



Customer Care

For details on Hotpoint's best in class Customer Care please call 08448 22 42 24, (0818 31 34 13 for Republic of Ireland) available 364 days a year or visit www.hotpointservice.co.uk

Need an Answer?

If you have a question about any Hotpoint appliance we can give you information about individual models, ranges and specific features.

Our information line is open from 8.30am to 5pm Monday to Friday. Please call 08000 92 19 22, (0818 36 50 08 for Republic of Ireland)



OUR IDEAS. YOUR HOME.

Indesit Company
Morley Way, Peterborough,
PE2 9JB, UK
www.hotpoint.co.uk
www.hotpoint.ie
Brochure No. P807

Published April 2010